

## General Safety Information

### WARNING

- Please use extra caution to keep your fingers away from the rotating disc brake rotor during installing or servicing the wheel. The rotor is sharp enough to inflict severe injury to your fingers if caught within the openings of moving rotor.
- The calipers and rotor will become hot when the brakes are operated, so do not touch them while riding or immediately after dismounting from the bicycle, otherwise you may get burned. Check that the brake components have cooled down sufficiently before attempting to adjust the brakes.
- The required braking distance will be longer during wet weather. Reduce your speed and apply the brakes early and gently.
- If the road surface is wet, the tires will skid more easily. If the tires skid, you may fall off the bicycle. To avoid this, reduce your speed and apply the brakes early and gently.
- Always make sure that the front and rear brakes are working correctly before you ride the bicycle.
- Be careful not to allow any oil or grease to get onto the rotor and brake pads, otherwise the brakes may not work correctly.
- If any oil or grease do get on the pads, you should replace the pads. If any oil or grease gets on the rotor, you should clean the rotor. If this is not done, the brakes may not work correctly.
- Before riding the bicycle, check that the pad thicknesses are 0.5 mm or more.
- Vapor lock may occur if the brakes are applied continuously. To relieve this condition, momentarily release the lever.

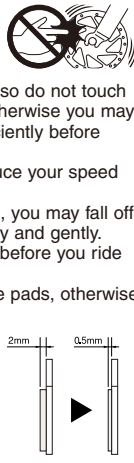

Vapor lock is a phenomenon in which the oil inside the brake system becomes heated, which causes any water or air bubbles inside the brake system to expand. This can then result in a sudden increase in the brake lever stroke.

- Use only genuine Shimano mineral oil. If other types of oil are used, it may cause problems with brake operation, and cause the system to be unusable.
- Be sure to use only oil from a freshly-opened container, and do not re-use oil which has been drained from the bleed nipple. Old oil or already-used oil may contain water which could cause vapor lock in the brake system.
- Be careful not to let water or air bubbles to get into the brake system, otherwise vapor lock may occur. Be particularly careful when removing the cover of the reservoir tank.
- When turning the bicycle upside down or on its side the brake system may have some air bubbles inside the reservoir tank which are still there when the reservoir tank cover is replaced, or which accumulate in various parts of the brake system when it is used for long periods. The M585 disc brake system is not designed to be turned upside down. If the bicycle is turned upside down or on its side, the air bubbles inside the reservoir tank may move in the direction of the calipers. If the bicycle is ridden in this condition, there is the danger that the brakes may not operate and a serious accident could occur.

If the bicycle has been turned upside down or on its side, be sure to operate the brake lever a few times to check that the brakes operate normally before riding the bicycle. If the brakes do not operate normally, adjust them by the following procedure.

#### < If brake operation is sluggish when the lever is depressed >

Set the brake lever so that it is parallel to the ground, and then gently depress the brake lever several times and wait for the bubbles to return to the reservoir tank. It is recommended that you then remove the reservoir tank cover and fill the reservoir tank with mineral oil until no bubbles remain. If the brakes still operate sluggishly, bleed the air from the brake system. (Refer to "Adding the mineral oil and bleeding air".)

- If fluid leaks occur, immediately stop using the brakes and carry out the appropriate repairs. If you continue riding the bicycle while fluid is leaking, there is the danger that the brakes may suddenly stop working.
- Check that the quick release lever is on the right side (the opposite side to the rotor). If the quick release lever is on the same side as the rotor, there is the danger that it may interfere with the rotor, so check that it does not interfere.
- It is important to completely understand the operation of your bicycle's brake system. Improper use of your bicycle's brake system may result in a loss of control or an accident, which could lead to severe injury. Because each bicycle may handle differently, be sure to learn the proper braking technique (including brake lever pressure and bicycle control characteristics) and operation of your bicycle. This can be done by consulting your professional bicycle dealer and the bicycle's owners manual, and by practicing your riding and braking technique.
- The M585 disc brakes are designed for optimum performance when used in combination with the BR-M585 (calipers), ST-M585/BL-M585 (brake lever), SM-RT62 (rotor) and Shimano pad unit.
- Obtain and read the service instructions carefully prior to installing the parts. Loose, worn, or damaged parts may cause injury to the rider.
- We strongly recommend only using genuine Shimano replacement parts.
- Read these Technical Service Instructions carefully, and keep them in a safe place for later reference.

### CAUTION

- M07-S brake pads are designed to reduce the amount of noise which is generated between the pads and the rotor when the brakes are operated. A longer running-in period is required for this type of pad compared to M06 pads.

#### Handling the mineral oil

- Use safety glasses when handling, and avoid contact with eyes. Contact with eyes may result in irritation. In the event of eye contact, flush with fresh water and seek medical assistance immediately.
- Use gloves when handling. Contact with skin may cause a rash and discomfort. In the event of skin contact, wash well with soap and water.
- Inhalation of oil mist or vapors may cause nausea. Cover nose and mouth with a respirator type mask and use in a well ventilated area. If mist or vapor is inhaled, go immediately to an area with fresh air. Cover up with a blanket. Stay warm and stable and seek professional medical advice.
- Do not drink. May cause vomiting or diarrhea.
- Keep out of reach of children.
- Do not cut, heat, weld or pressurize the oil container, as this may cause explosion or fire.
- Disposal of Used Oil : Follow local county and/or state codes for disposal. Use care when preparing oil for disposal.
- Directions : Keep the container sealed to prevent foreign objects and moisture from getting inside, and store it in a cool, dark area away from direct sunlight or heat.

## Technical Service Instructions

SI-8DB0C-001

## Disc Brake System (For Cross-Country)



In order to realize the best performance, we recommend that the following combination be used.

Caliper	BR-M585	Cable Supporter	SM-HANG
Brake Lever	ST-M585 / BL-M585	Mineral Oil	SM-DB-OIL
Rotor	SM-RT62	Brake pad unit	Resin Pads M07-S Metal Pads M06
Hose	SM-BH59		

### Burn-in period

- Disc brakes have a burn-in period, and the braking force will gradually increase as the burn-in period progresses. Make sure that you are aware of any such increases in braking force when using the brakes during the burn-in period. The same thing will happen when the brake pads or rotor are replaced.

### When cleaning with a compressor

- If disassembling the caliper body to clean the internal parts using a compressor, note that moisture from the compressed air may remain on the caliper components. Let the caliper components dry sufficiently before reassembling the calipers.

### Note

- If the brake caliper mounting boss and the dropout are not parallel, the rotor and caliper may touch.
- When the bicycle wheel has been removed, it is recommended that pad spacers should be installed. The pad spacers will prevent the piston from coming out if the brake lever is depressed while the wheel is removed.
- If the brake lever is depressed without the pad spacers installed, the pistons will protrude further than is normal. Use a flat-tipped screwdriver or similar tool to push back the brake pads, while being careful not to damage the surfaces of the brake pads. (If the brake pads are not installed, push the pistons straight back in, while being careful not to damage them.) If it is difficult to push the brake pads or pistons back, remove the reservoir tank cover and then try again. (Note that some oil may overflow from the reservoir tank at this time.)
- Use isopropyl alcohol, soapy water or a dry cloth when carrying out cleaning and maintenance of the brake system. Do not use commercially-available brake cleansers or silencing agents, as they can cause damage to parts such as seals.
- Do not remove the pistons when disassembling the calipers.
- If the rotor is worn, cracked or warped, it should be replaced.
- Parts are not guaranteed against natural wear or deterioration resulting from normal use.
- For maximum performance we highly recommend Shimano lubricants and maintenance products.

The installation method for the brake lever is described in the BL-M585 Service Instructions.

## Installation

The following tools are needed to assemble this product.

Usage location	Tool
Rotor installation ring	TL-LR15
Brake lever fixing bolt	Allen key 5 mm
Caliper fixing bolt / Adapter fixing bolts	Allen key 5 mm
Brake pad fixing shaft	Radio pliers
Brake hose fixing bolt	8 mm wrench
Reservoir tank cover	Phillips screwdriver #1
Cable supporter	Phillips screwdriver #2
Bleed nipple	Socket wrench 7 mm

### Wheel spoke lacing

Check that the spokes have been laced as shown in the illustration. A radial assembly cannot be used.

Lace the spokes as shown in Figure 1 below for the left side of the front wheel (the side where the rotor is installed), and the left and right sides of the rear wheel, and as shown in Figure 2 below for the right side of the front wheel.

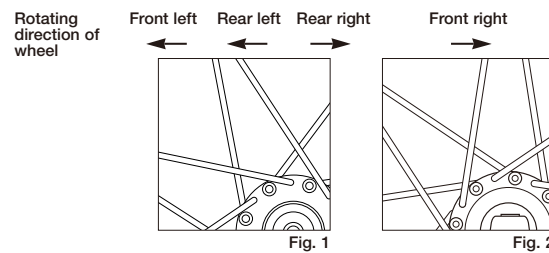

### Installation of the rotor (SM-RT62)

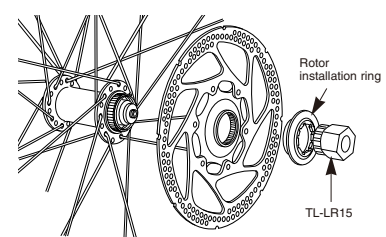

Tightening torque:  
40 N·m [350 in. lbs.]

### Installation of the brake lever (BL-M585)

Secure the brake lever as shown in the illustration. (Check that the brake lever does not interfere with the shifting lever during operation. Refer to the Service Instructions for the shifting lever also. Some types might require the shifting lever to be installed first, due to the position of the shifting lever fixing bolts.)

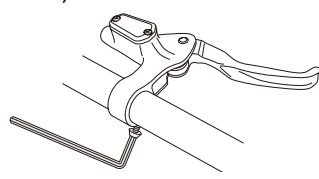

Brake lever Tightening torque:  
6 - 8 N·m [53 - 69 in. lbs.]

In the case of carbon handlebars, it may be necessary to lower the tightening torque in order to prevent damage to the handlebar. Please consult the bicycle or handlebar manufacturer regarding the appropriate level of tightening torque for carbon handlebars.

### Installation of the hose

Refer to the Service Instructions for the SM-BH59 brake hose (SI-8H20) for details on installing the hose. Do not let the hose become twisted when installing. Make sure that the calipers and levers are in the positions shown in the illustrations.

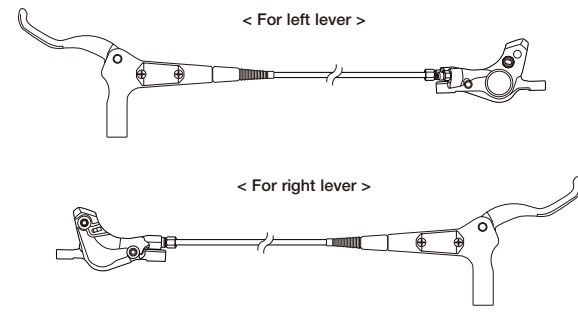

## Adding mineral oil and bleeding air

- With the pad spacers still attached to the calipers, place the bicycle into a bicycle stand or similar as shown in the illustration. Set the brake lever so that it is parallel to the ground, and then remove the reservoir tank cover.

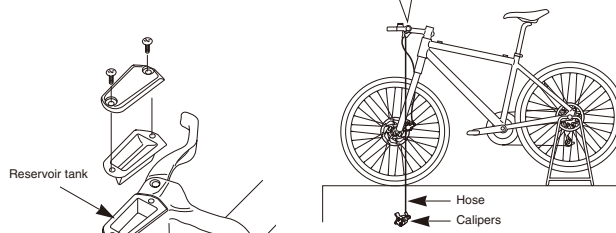

- Set a 7mm socket wrench in place, attach a bag to the tube, and then place the tube onto the bleed nipple as shown in the illustration.

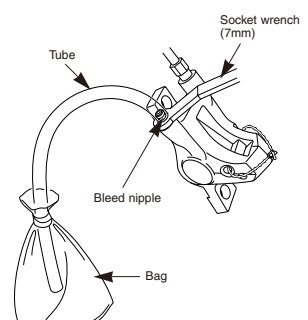

- Loosen the bleed nipple by 1/8th of a turn to open it, and then pour oil into the reservoir tank. Gently operate the brake lever while doing this to help prime the system with the oil.

- When the oil goes into the hose, the oil level in the reservoir tank will drop, so be sure to continue adding oil to maintain the oil level so that air is not drawn in through the port.

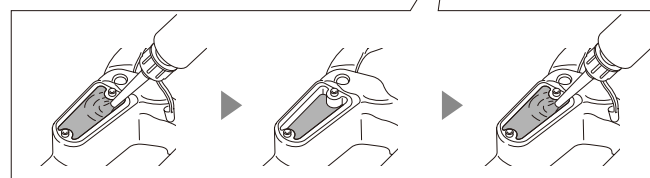

If oil periodically comes out from the bleed nipple, tighten the bleed nipple for a while.

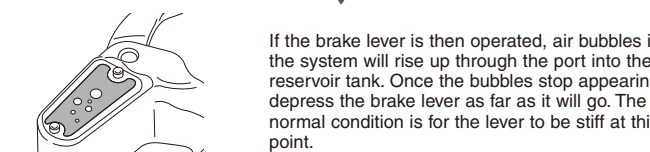

#### Lever operation

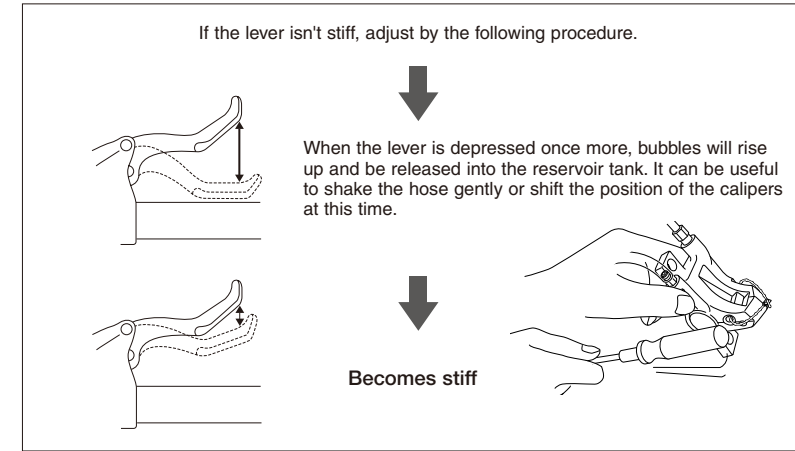
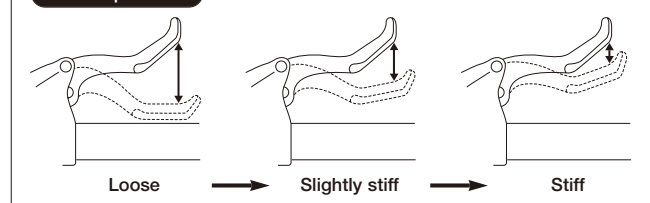

- With the brake lever depressed, open and close the bleed nipple in rapid succession (for approximately 0.5 seconds each time) to release any air bubbles which may be in the calipers. Repeat this procedure about 2 to 3 times. Then tighten the bleed nipple again.

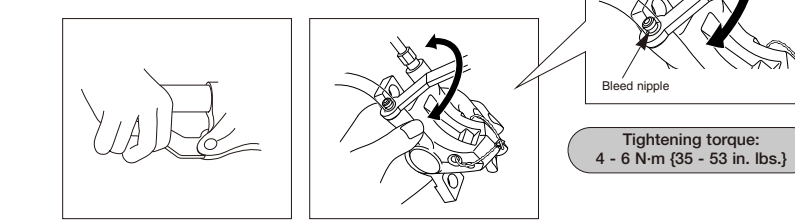

- Fill the reservoir tank with oil and then replace the reservoir tank cover. Fill the reservoir tank to overflowing with oil while replacing the cover to ensure that no air bubbles remain inside the reservoir tank. In addition, be careful not to get any oil on parts such as the rotor and brake pads.

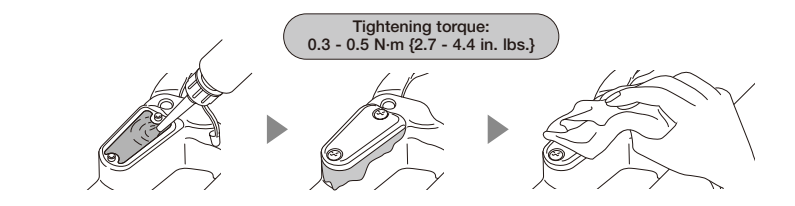

- Return the brake lever to its original position.

**Note:**  
Do not use brake fluid fillers, as they can cause small bubbles of air to form, and such bubbles can cause severe drops in braking performance.

### Installation of the calipers (BR-M585) and securing the hose

- Remove the pad spacer (A) (yellow), and then set the wheel which has the rotor onto the frame.
- Install the brake pads. After this, bend open the split pin.

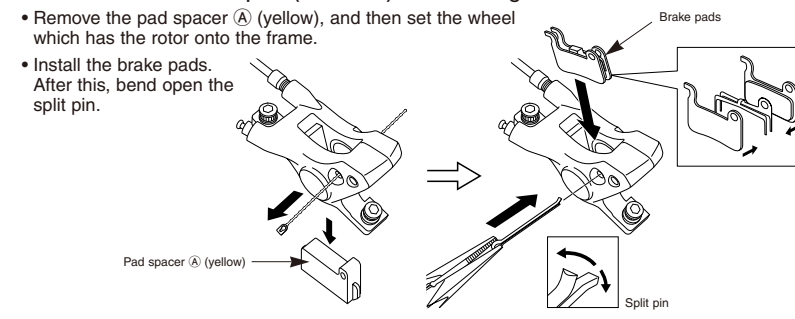

For international-standard mounts, attach adapters to calipers for post-type mounts. (Separate front and rear adapters are available.)

- Loosen the caliper fixing bolts so that the caliper can move sideways, and then install the adapter to the frame.
- Depress the brake lever so that the rotor is being clamped by the pads, and then tighten the caliper fixing bolts.

#### International standard mounting type

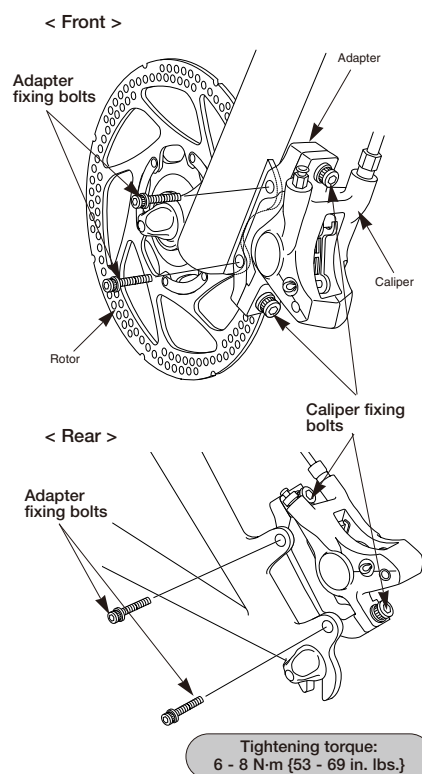

#### Post mounting type

Provisionally install the caliper to the frame (so that the caliper can move sideways), depress the brake lever so that the rotor is being clamped by the pads, and then tighten the caliper fixing bolts.

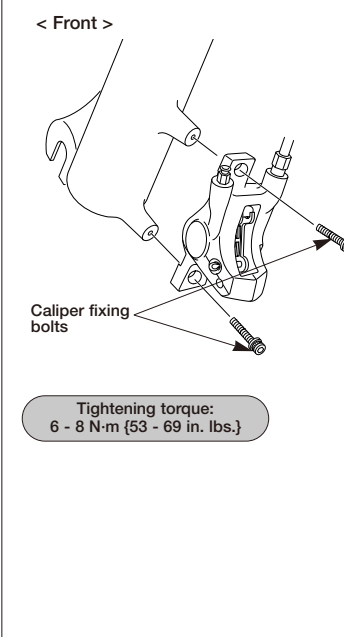

Either a cap method or a wire ring method can be used to stop the bolts from turning. Use whichever method is suitable for the front fork and frame.

### Cap method

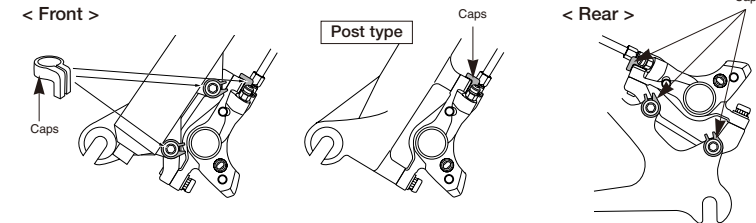

### Wire ring method

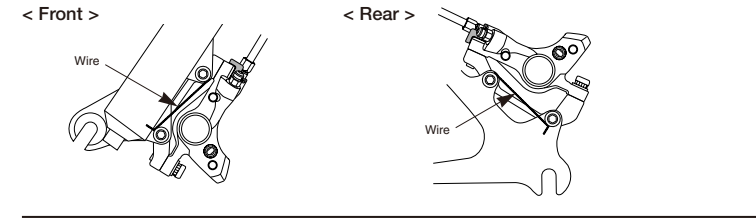

For C-shaped guides and the usual type of cable stoppers, use the special Shimano cable supporter (sold separately) to secure as shown in the illustration.

Tightening torque:  
0.3 - 0.5 N·m [2.7 - 4.4 in. lbs.]

Operate the brake lever several times and check whether the brakes operate normally or not. Also check that there are no oil leaks visible.

## Maintenance

### Brake pad replacement

**Note:** The M585 brake system is designed so that as the brake pads become worn, the pistons gradually move outward to automatically adjust the clearance between the rotor and the brake pads. Therefore, you need to push the pistons back to their original positions when replacing the brake pads.

If oil adheres to the brake pads after oil is added, or if the brake pads are worn down to a thickness of 0.5 mm, replace the brake pads.

- Remove the wheel from the frame, and remove the brake pads as shown in the illustration.
- Clean the pistons and surrounding area.
- Set the brake lever so that it is parallel to the ground, and then remove the reservoir tank cover.

- Push the piston back in as far as it will go, while being careful not to twist it. (Note that some oil may overflow from the reservoir tank at this time.)

- Install the new brake pads, and then install the pad spacers (B) (red). After this, bend open the split pin.

- Depress the brake lever several times to check that the operation becomes stiff.

- Check that the rotor and the brake pads do not touch each other, and then check the oil level (adding more oil if required). After doing this, replace the reservoir tank cover.

### Adjustment when the pistons are not operating correctly

The caliper mechanism includes two pistons. If these pistons do not operate properly or if they protrude unevenly, or if the brake pads remain in contact with the rotor, adjust the pistons by the following procedure.

- Remove the wheel and the brake pads. Clean the pistons and surrounding area, set the brake lever so that it is parallel to the ground, and remove the reservoir tank cover.
- Push the piston back in straight, without bending it. Note that some oil may overflow from the reservoir tank at this time.
- Install the brake pads and the pad spacers (B) (red).
- Depress the brake lever as far as it will go, and then operate it several more times so that the two pistons all move to their initial positions.
- Remove the pad spacers, install the wheel, and then check that there is no interference between the rotor and the caliper. If they are touching, adjust while referring to "Installation of the caliper".
- After checking the oil level, replace the reservoir tank cover.
- Return the brake lever to its original position.

### Mineral oil replacement

It is recommended that you replace the oil inside the reservoir tank if it becomes severely discolored.

Attach a tube with a bag to the bleed nipple, and then open the bleed nipple and drain out the oil. You can operate the brake lever at this time to help the oil to drain out. After draining the fluid, pour in fresh brake fluid while referring to "Adding the mineral oil and bleeding air". Use only genuine Shimano mineral oil. Dispose of the waste oil according to proper country and/or state disposal regulations.

**SHIMANO**  
SHIMANO AMERICAN CORPORATION  
One Holland, Irvine, California 92618, U.S.A. Phone: +1-949-951-5003  
SHIMANO EUROPE B.V.  
Industrieweg 24, 8071 CT Nunspeet, The Netherlands. Phone: +31-341-272222  
SHIMANO INC.  
3-77 Omuro-cho, Sakai-ku, Sakai-shi, Osaka 590-8577, Japan

Please note: specifications are subject to change for improvement without notice. (English)  
© Apr. 2007 by Shimano Inc. XBC IZM Printed in Japan.